

Adattabile a : **SCANIA GRS(O)900-GRS(O)900R (W/Retarder)**
 Suitable To :

Oil Seal & Gasket Kit
89 - 90 - 91



Oil Pump
84



Oil Filter
85

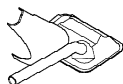

Oil Filter
86



Split Cylinder
O-Ring Kit
 ● = 92

Kits	
x 4	x 12
x 4	x 12
x 4	x 12
Kit 87	Kit 88

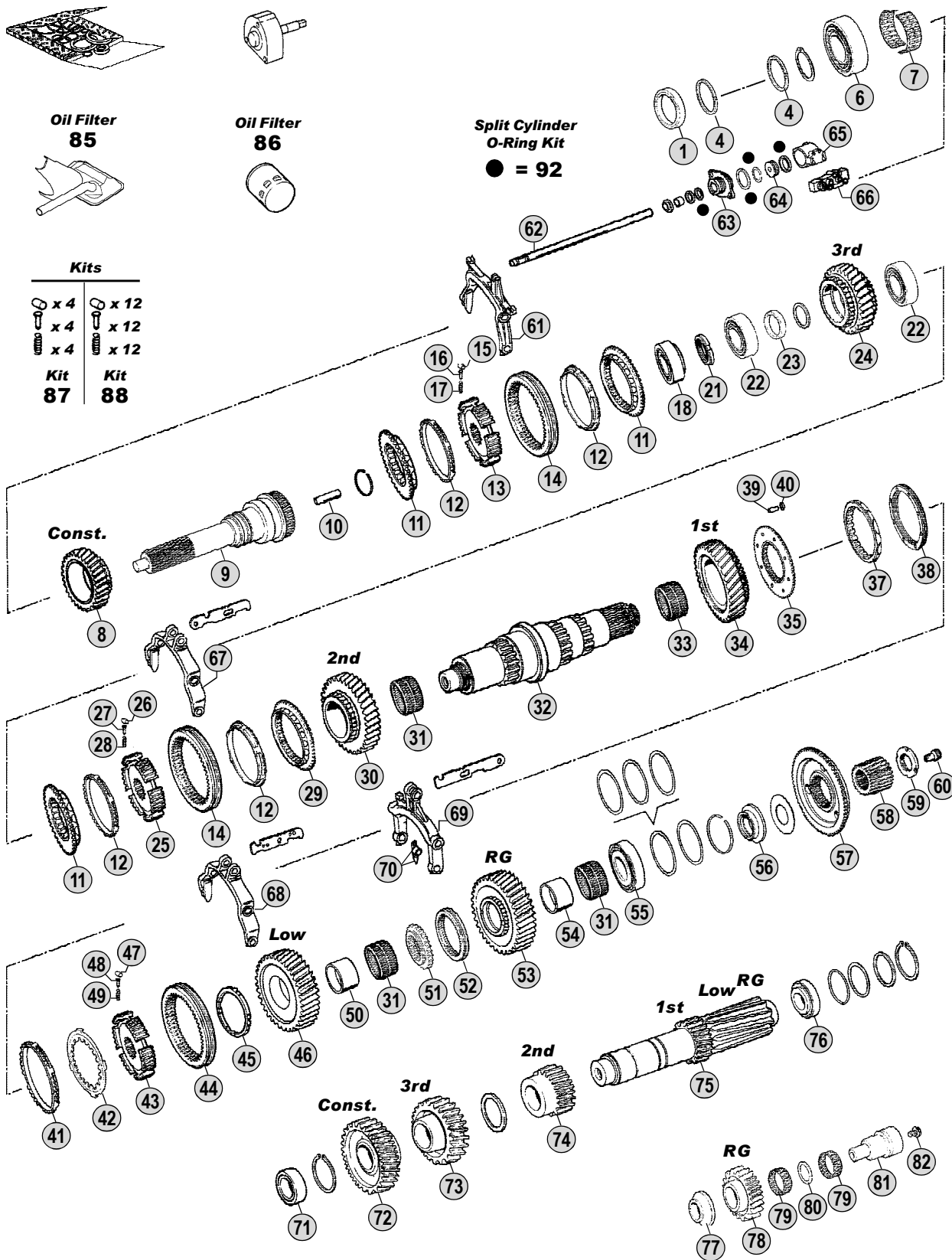

All original equipment manufacturer's numbers, symbols, pictures, models and description used in this catalogue are for reference only, and it is not implied that any part listed is the product of these manufactures. Tutti i nostri particolari non sono originali ma con essi intercambiabili. I riferimenti originali, le figure, i modelli sono esposti a semplice titolo indicativo. La nostra produzione riporta il nostro marchio.

Models

Serie 4 - Serie P - Serie R

94C/D/G/L - 114C/G/L/ - 124C/G/L - 144C/G/L - 164(480)C/G/L

P/R380 - P/R420 - P/R480 - P/R500 - P/R560 - P/R620



Fig.	CEI no.	Rif. SCANIA	Description	Q.ty	Note	GRS(O)900	GRS(O)900R		
1	139.567	1318388	Oil Seal 55x75x9	1		●	●		
4	139.582	1515004	Ring	2		●	●		
6	130.528	1327878	Bearing D.65x150x40	1	Oem	●	●		
6	530.528	1327878	Bearing D.65x150x40	1	A.Market	●	●		
7	137.169	372778	Needle Cage 92X100X44	1		●	●		
8	145.717	1393882	Constant Gear 36 T	1		●	●		
9	102.264	1377307	Input Shaft	1		●	●		
9	102.334	1378579	Input Shaft	1	EK-PTO	●	●		
10	189.502	315060	Oil tube	1		●	●		
11	109.167	1116475	Synchronizer Cone	3		●	●		
12	119.145	1382465	Synchronizer Ring	4	(A)	●	●		
12	119.236	1756447	Synchronizer Ring	4	(B)	●	●		
13	157.552	1376499	Synchronizer Hub	1		●	●		
14	154.194	369906	Sliding Sleeve	2	(A)	●	●		
14	154.386	1529939	Sliding Sleeve	2	(B)	●	●		
15	160.198	374334	Roller	4		●	●		
16	160.199	369910	Pin	4		●	●		
17	156.177	369911	Spring	4		●	●		
18	130.821	1548817	Bearing 40x85x33	1		●	●		
21	187.647	1461414	Nut	1		●	●		
22	130.531	1548056	Bearing	2		●	●		
23	111.238	1302731	Spacer T.9,50 mm	1		●	●		
23	111.239	1302732	Spacer T.9,52 mm	1		●	●		
23	111.240	1302733	Spacer T.9,54 mm	1		●	●		
23	111.241	1302734	Spacer T.9,56 mm	1		●	●		
23	111.242	1302735	Spacer T.9,58 mm	1		●	●		
24	145.511	1367794	Gear 3rd Speed 32 T	1		●	●		
25	157.553	1405981	Synchronizer Hub	1		●	●		
26	160.198	374334	Roller	4		●	●		
27	160.199	369910	Pin	4		●	●		
28	156.177	369911	Spring	4		●	●		
29	109.165	1116477	Synchronizer Cone	1		●	●		
30	145.512	1116461	Gear 2nd Speed 35 T	1		●	●		
31	137.170	378628	Needle Cage D.80x88x40	3		●	●		
32	103.136	1382978	Main Shaft	1		●	●		
33	137.171	378616	Needle Cage D.80x88x55	1		●	●		
34	145.575	1393876	Gear 1st Speed 44 T	1		●	●		
35	109.166	1300061	Synchronizer Cone	1		●	●		
37	119.203	1438526	Synchronizer Ring	1		●	●		
38	119.147	1383895	Intermediate Synchro Ring	1	(A)	●	●		
38	119.235	1466318	Intermediate Synchro Ring	1	(B)	●	●		
39	160.193	1340002	Pin	8		●	●		
40	111.197	383138	Lock Ring	8		●	●		
41	119.146	1401620	Synchronizer Ring	1	(A)	●	●		
41	119.202	1529950	Synchronizer Ring	1	(B)	●	●		

Notes

(A) Standard Generation. Use items marked (A) together.

(B) LATEST GENERATION. Use items marked (B) together.

(*) Old and New Gen. Can be replaced by Synchro rebuilt kit 298.188 (Latest Gen.) shown in the next table.

(@) LATEST GENERATION. To be coupled together

Date

05 / 2010

Table

Adattabile a : **SCANIA GRS(O)900-GRS(O)900R (W/Retarder)**
 Suitable To :

Oil Seal & Gasket Kit
89 - 90 - 91



Oil Pump
84



Oil Filter
85

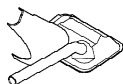

Oil Filter
86



Split Cylinder
O-Ring Kit
 ● = 92

Kits	
x 4	x 12
x 4	x 12
x 4	x 12
Kit 87	Kit 88

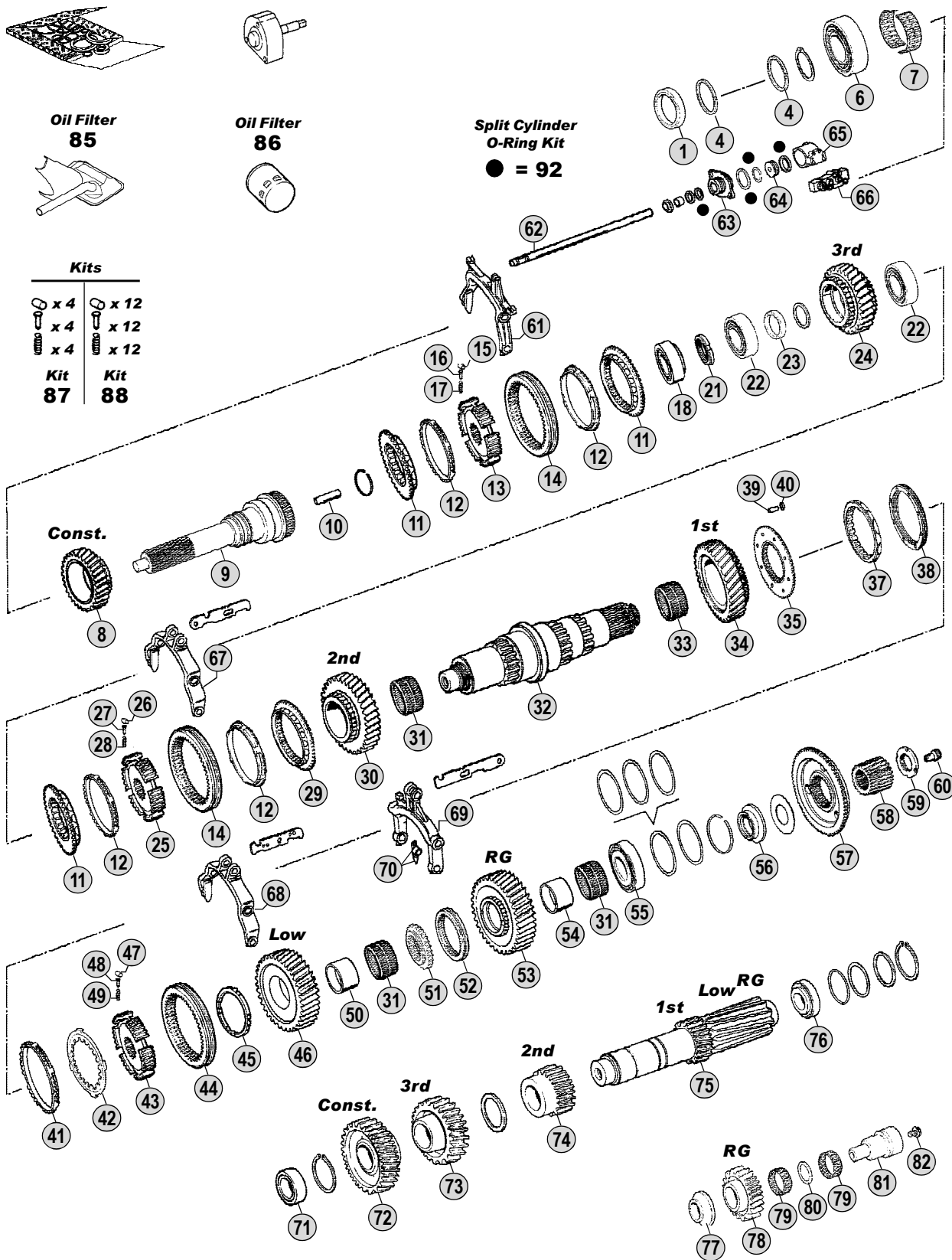

All original equipment manufacturer's numbers, symbols, pictures, models and description used in this catalogue are for reference only, and it is not implied that any part listed is the product of these manufactures. Tutti i nostri particolari non sono originali ma con essi intercambiabili. I riferimenti originali, le figure, i modelli sono esposti a semplice titolo indicativo. La nostra produzione riporta il nostro marchio.

Models

Serie 4 - Serie P - Serie R

94C/D/G/L - 114C/G/L/ - 124C/G/L - 144C/G/L - 164(480)C/G/L

P/R380 - P/R420 - P/R480 - P/R500 - P/R560 - P/R620



Fig.	CEI no.	Rif. SCANIA	Description	Q.ty	Note	GRS(O)900	GRS(O)900R		
42	169.740	1401622	Driver Plate	1	(A)	●	●		
42	169.848	1533848	Driver Plate	1	(B)	●	●		
43	157.553	1405981	Synchronizer Hub	1		●	●		
44	154.196	371692	Sliding Sleeve	1	(A)	●	●		
44	154.386	1529939	Sliding Sleeve	1	(B)	●	●		
45	111.237	395759	Ring	1		●	●		
46	145.577	1394865	Gear Low Speed 40 T	1		●	●		
47	160.198	374334	Roller	4		●	●		
48	160.199	369910	Pin	4		●	●		
49	156.177	369911	Spring	4		●	●		
50	117.366	1304852	Bush	1		●	●		
51	157.668	378627	Fixed Hub	1		●	●		
52	154.330	378646	Sliding Sleeve	1		●	●		
53	147.208	378633	Reverse Gear 36 T	1		●	●		
54	117.365	1304853	Bush	1		●	●		
55	130.528	1327878	Bearing D.65x150x40	1	Oem	●	●		
55	530.528	1327878	Bearing D.65x150x40	1	A.Market	●	●		
56	169.910	1113910	Spacer	1		●	●		
57	109.190	1304850	Synchronizer Cone	1	(*) Old Generation	●	●		
57	109.420	1789444	Synchronizer Cone	1	(*) New Generation	●	●		
57	109.755	1883354	Synchronizer Cone	1	(@) Latest Generation	●	●		
58	157.549	1459308	Sun Gear 24 T	1		●			
58	157.554	1459309	Sun Gear 24 T	1			●		
59	187.648	1461417	Nut	1		●			
59	187.649	1461416	Nut	1			●		
60	189.617	1387297	Oil Plug	1		●	●		
61	198.845	1335671	Fork	1		●	●		
62	149.261	1335174	Rod	1		●	●		
63	132.059	1305977	Intermediate Element	1		●	●		
64	189.620	1337894	Piston	1		●	●		
65	132.060	1345149	Cylinder	1		●	●		
66	280.548	1488083	Solenoid Valve	1		●	●		
67	141.171	1327286	Fork	1		●	●		
68	141.178	1479151	Fork	1		●	●		
69	141.180	1305971	Fork	1		●	●		
70	141.179	1423958	Slide	2		●	●		
71	130.295	1903570	Bearing D.50x100x37,65	1	Oem	●	●		
71	530.295	1903570	Bearing D.50x100x37,65	1	A.Market	●	●		
72	146.532	1393884	Constant gear 31 T	1		●	●		
73	146.430	1367796	Gear 3rd Speed 34 T	1		●	●		
74	146.497	1116473	Gear 2nd Speed 24 T	1		●	●		
75	105.126	1393880	Countershaft 19/12 T	1		●	●		
76	130.532	1357711	Bearing 60X130X33,5	1	Oem	●	●		
76	530.532	1357711	Bearing 60X130X33,5	1	A.Market	●	●		
77	169.907	378614	Washer	1		●	●		

Notes

(A) Standard Generation. Use items marked (A) together.

(B) LATEST GENERATION. Use items marked (B) together.

(*) Old and New Gen.Can be replaced by Synchro rebuilt kit 298.188 (Latest Gen.) shown in the next table.

(@) LATEST GENERATION. To be coupled together

Date

05 / 2010

Table

Adattabile a : **SCANIA GRS(O)900-GRS(O)900R (W/Retarder)**
 Suitable To :

Oil Seal & Gasket Kit
89 - 90 - 91



Oil Pump
84



Oil Filter
85



Oil Filter
86



Split Cylinder O-Ring Kit
● = 92

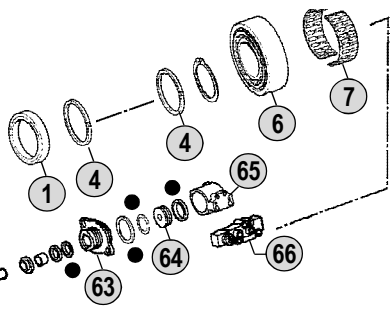

Kits	
x 4	x 12
x 4	x 12
x 4	x 12
Kit 87	Kit 88

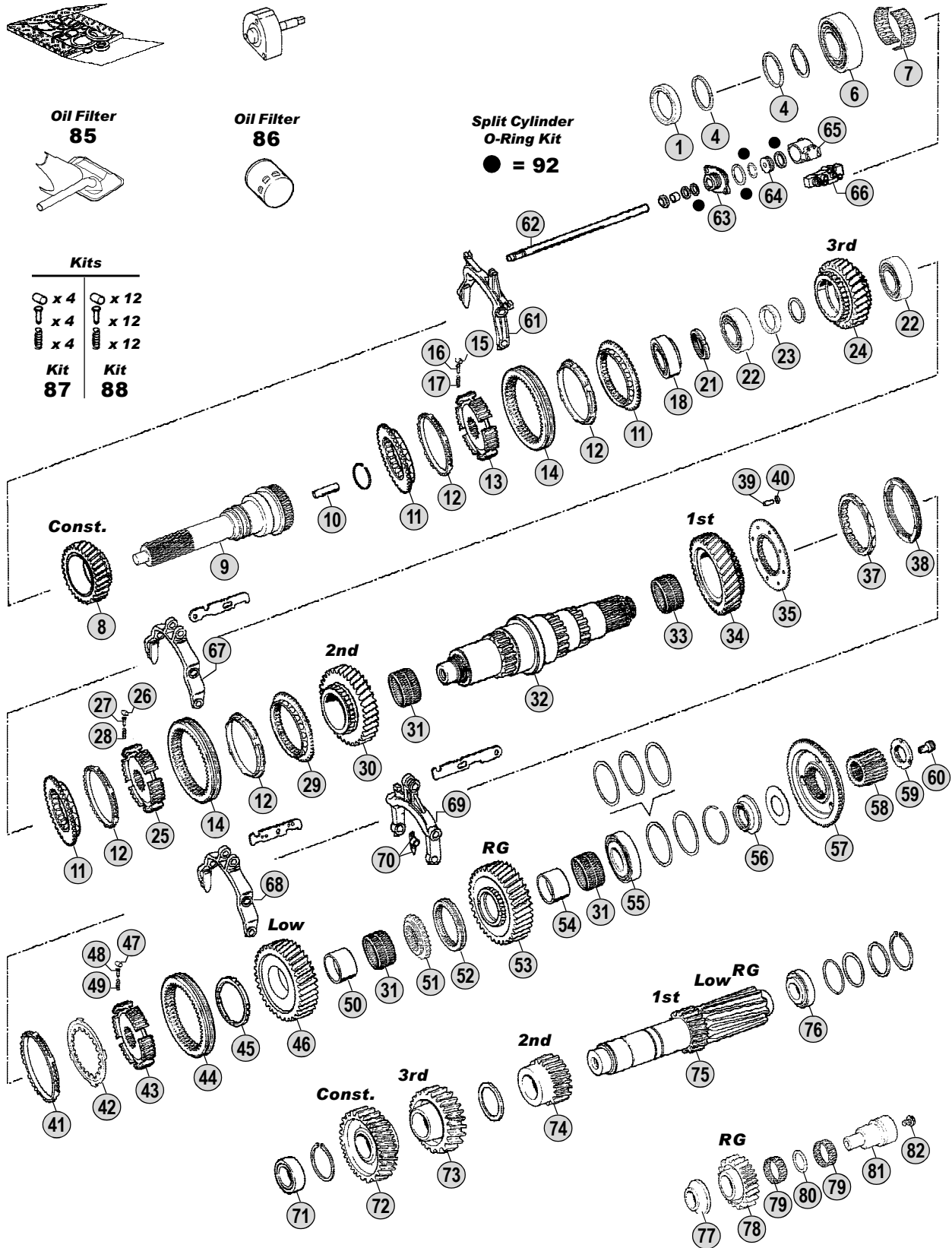

All original equipment manufacturer's numbers, symbols, pictures, models and description used in this catalogue are for reference only, and it is not implied that any part listed is the product of these manufactures. Tutti i nostri particolari non sono originali ma con essi intercambiabili. I riferimenti originali, le figure, i modelli sono esposti a semplice titolo indicativo. La nostra produzione riporta il nostro marchio.

Models

Serie 4 - Serie P - Serie R

94C/D/G/L - 114C/G/L/ - 124C/G/L - 144C/G/L - 164(480)C/G/L

P/R380 - P/R420 - P/R480 - P/R500 - P/R560 - P/R620



GRS(O)900
GRS(O)900R

Fig.	CEI no.	Rif. SCANIA	Description	Q.ty	Note				
78	147.209	380110	Reverse Gear	1		●	●		
79	137.172	378615	Needle Cage D.50x62x21,5	2		●	●		
80	169.908	380109	Spacer	1		●	●		
81	147.203	1510337	Reverse Pin	1		●	●		
82	187.650	812534	Screw	1		●	●		
84	280.540	1426449	Oil Pump	1		●	●		
85		1503775	Oil Filter	1		●	●		
86	280.612	1768402	Oil Filter	1		●	●		
87	198.847	CEI 198847	Roller-Pins and Springs kit	1		●	●		
88	198.848	CEI 198848	Roller-Pins and Springs kit	1		●	●		
89	198.850	CEI 198850	Gasket kit	1	Only gaskets	●	●		
90	198.851	CEI 198851	Oil Seals Kit	1	Only oil seals	●	●		
91	198.846	550577	Oil Seal and Gasket Kit	1	Complete	●	●		
92	198.956	CEI 198956	Split Cylinder O-Ring Kit	1		●	●		

All original equipment manufacturers numbers, symbols, pictures, models and description used in this catalogue are for reference only, and it is not implied that any part listed is the product of these manufactures.
Tutti i nostri particolari non sono originali ma con essi intercambiabili. I riferimenti originali, le figure, i modelli sono esposti a semplice titolo indicativo. La nostra produzione riporta il nostro marchio.

Notes

Date

(A) Standard Generation. Use items marked (A) together.

05 / 2010

(B) LATEST GENERATION. Use items marked (B) together.

(*) Old and New Gen. Can be replaced by Synchro rebuilt kit 298.188 (Latest Gen.) shown in the next table.

(@) LATEST GENERATION. To be coupled together

Table

Adattabile a : **SCANIA GRS(O)900-GRS(O)900R (W/Retarder)**
 Suitable To :

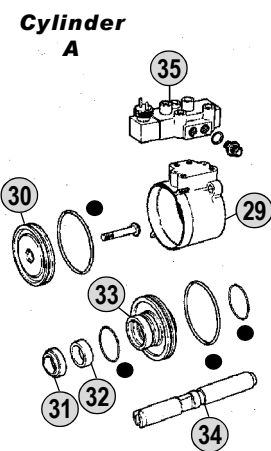
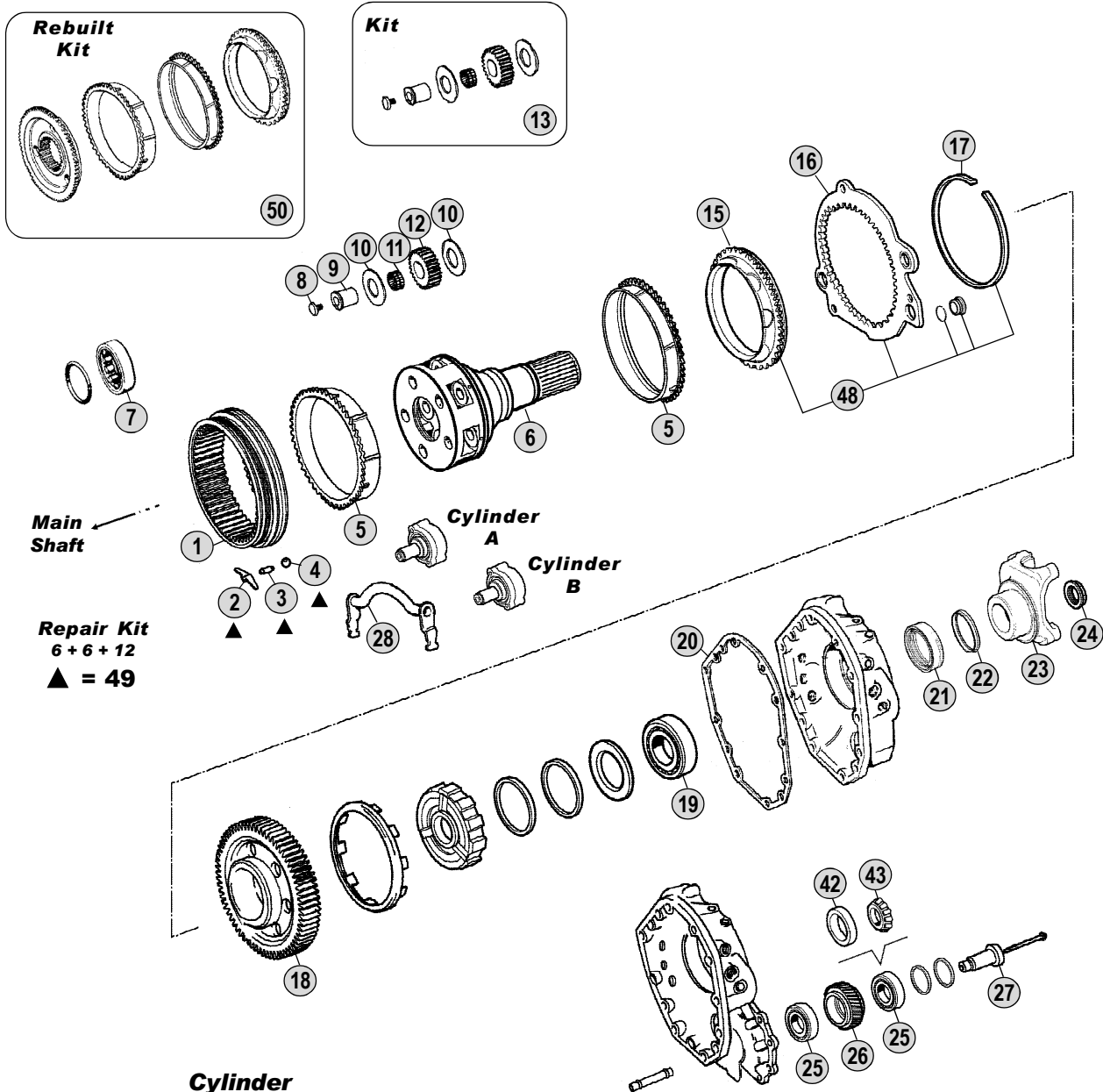

O-Ring Kit
● = 47

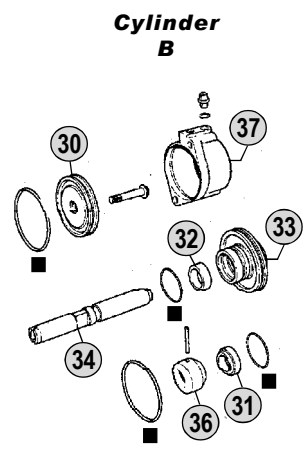

O-Ring Kit
■ = 47

Oil Seal & Gasket Kit
44 - 45 - 46

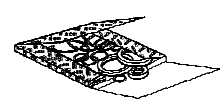

Oil Filter
40

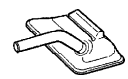

Oil Pump
39



Oil Filter
41



All original equipment manufacturers' numbers, symbols, pictures, models and description used in this catalogue are for reference only, and it is not implied that any part listed is the product of these manufacturers. Tutti i nostri particolari non sono originali ma con essi intercambiabili. I riferimenti originali, le figure, i modelli sono esposti a semplice titolo indicativo. La nostra produzione riporta il nostro marchio.

Models

Serie 4 - Serie P - Serie R
94C/D/G/L - 114C/G/L - 124C/G/L - 144C/G/L - 164(480)C/G/L
P/R380 - P/R420 - P/R480 - P/R500 - P/R560 - P/R620



Fig.	CEI no.	Rif. SCANIA	Description	Q.ty	Note	GRS(O)900	GRS(O)900R			
1	123.216	1118030	Crown Gear 66 T	1		●	●			
2	156.185	1395039	Spring	6		●	●			
3	160.215	1332508	Pin	6		●	●			
4	160.216	871702	Ball	12		●	●			
5	119.121	1395624	Synchronizer Ring	2	(*) Old Generation	●	●			
5	119.249	1770058	Synchronizer Ring	2	(*) New Generation	●	●			
5	119.288	1883363	Synchronizer Ring	2	(@) Latest Generation	●	●			
6	190.332	1318221	Planetary Carrier	1	Complete	●				
6	190.333	1318225	Planetary Carrier	1	Complete		●			
7	130.622	1300596	Bearing	1			●			
8	187.606	1318714	Screw	5		●	●			
9	107.171	1318713	Pin	5		●	●			
10	169.796	389419	Washer	10		●	●			
11	137.168	389434	Needle Bearing	5		●	●			
12	157.199	1373174	Planet Pinion 20 T	5		●	●			
13	198.849	CEI 198849	Repair kit	5		●	●			
15	109.168	1323147	Synchronizer Cone	1	(*) Old Generation	●	●			
15	109.421	1788170	Synchronizer Cone	1	(*) New Generation	●	●			
15	109.756	1883350	Synchronizer Cone	1	(@) Latest Generation	●	●			
16	135.126	1323145	Saddle Plate	1		●	●			
17	111.207	1302665	Snap Ring	1		●	●			
18	145.743	1426758	Retarder Gear 70 T	1			●			
19	130.533	1783324	Bearing D.60x130x31	1		●	●			
20	139.574	1305139	Gasket	1		●	●			
21	139.568	1502384	Oil Seal 85x105x13	1		●	●			
22	139.481	1300977	Dust Cover	1		●	●			
23	197.106	1340753	Output Flange	1	P30/300	●	●			
23	155.198	1422427	Output Flange	1	P40/400	●	●			
23	197.107	1422430	Output Flange	1	P50/P500	●	●			
23	197.076	1319646	Output Flange	1	P60/P600	●	●			
24	187.486	1525988	Nut M44x1,5	1		●	●			
25	130.621	361043	Bearing 40x85x33	2	Oem Old Type		●			
25	530.621	361043	Bearing 40x85x33	2	A.Market Old Type		●			
26	145.744	1373704	Gear 34 T	1			●			
27	107.188	1304747	Pin	1			●			
28	141.175	1491403	Fork	1		●	●			
29	132.056	1484808	Cylinder	1		●	●			
30	189.618	1303960	Piston	2		●	●			
31	139.601	1515869	Oil Seal Ring 22X28X5/8	2		●	●			
32	117.362	1303799	Bush	2		●	●			
33	132.057	1321239	Intermediate Element	2		●	●			
34	107.189	1332131	Shaft	2		●	●			
35	280.548	1488083	Solenoid Valve	1		●	●			
36	117.363	1337828	Sleeve	1		●	●			
36	117.364	1382339	Sleeve	1		●	●			

Notes

(*) Old and New Generation. Can be replaced by Synchro rebuilt kit **298.188** (Fig. 50)
 (@) LATEST GENERATION. To be coupled together.

Date

05 / 2010

Table

0175

Adattabile a : **SCANIA GRS(O)900-GRS(O)900R (W/Retarder)**
 Suitable To :

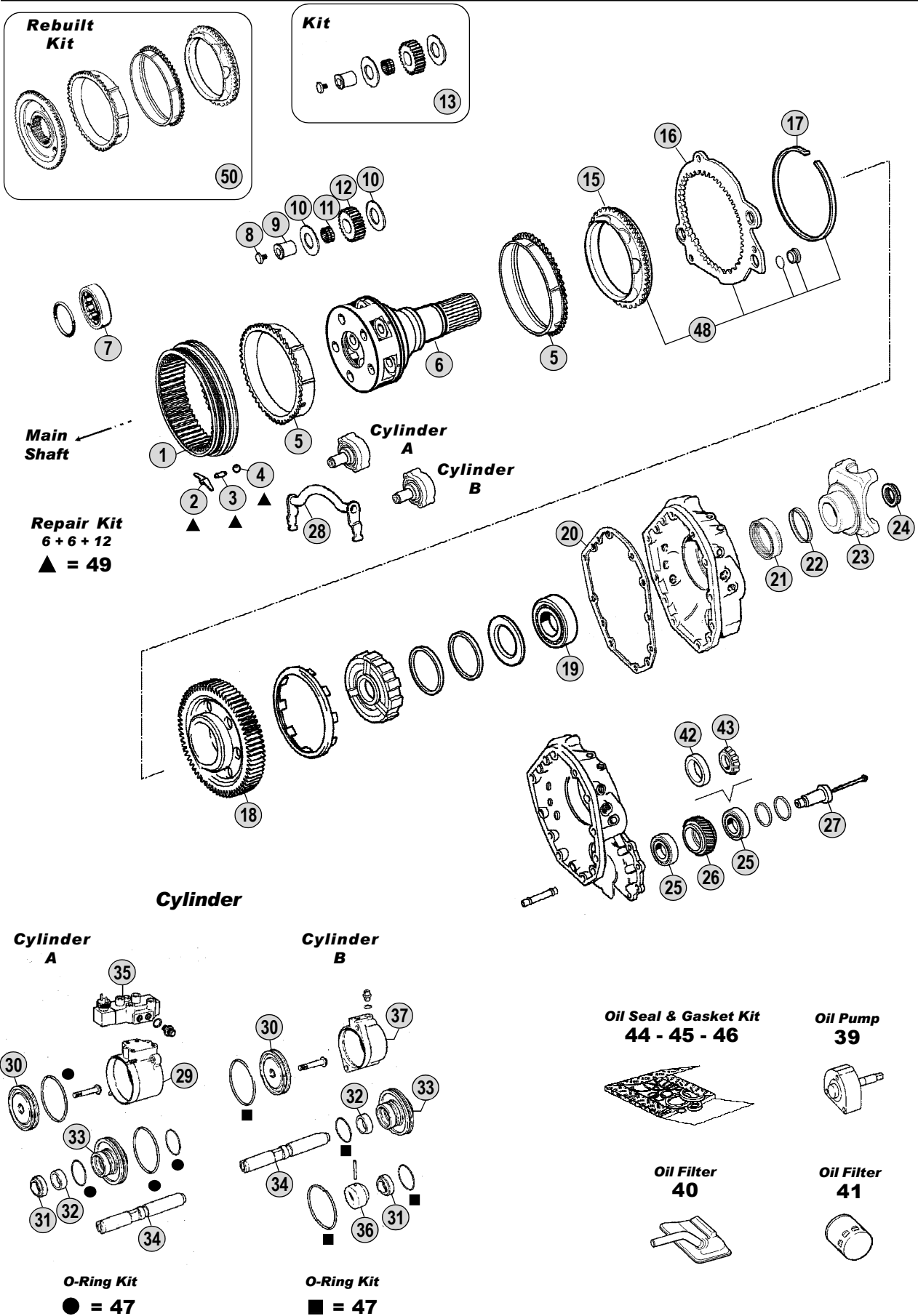

All original equipment manufacturers numbers, symbols, pictures, models and description used in this catalogue are for reference only, and it is not implied that any part listed is the product of these manufactures.
 Tutti i nostri particolari non sono originali ma con essi intercambiabili. I riferimenti originali, le figure, i modelli sono esposti a semplice titolo indicativo. La nostra produzione riporta il nostro marchio.

Models

Serie 4 - Serie P - Serie R

94C/D/G/L - 114C/G/L/ - 124C/G/L - 144C/G/L - 164(480)C/G/L

P/R380 - P/R420 - P/R480 - P/R500 - P/R560 - P/R620



GRS(O)900
GRS(O)900R

All original equipment manufacturers' numbers, symbols, pictures, models and description used in this catalogue are for reference only, and it is not implied that any part listed is the product of these manufacturers. Tutti i nostri particolari non sono originali ma con essi intercambiabili. I riferimenti originali, le figure, i modelli sono esposti a semplice titolo indicativo. La nostra produzione riporta il nostro marchio.

Fig.	CEI no.	Rif. SCANIA	Description	Q.ty	Note		GRS(O)900	GRS(O)900R			
37	132.058	1484809	Cylinder	1		●	●				
39	280.540	1426449	Oil Pump	1		●	●				
40		1503775	Oil Filter	1		●	●				
41	280.612	1768402	Oil Filter	1		●	●				
42	130.529	1548819	Bearing Cone 85 mm	2	Oem New Type		●				
42	530.529	1548819	Bearing Cone 85 mm	2	A.Market New Type		●				
43	130.530	1883975	Roller Bearing 40x30 mm	2	New Type		●				
44	198.850	CEI 198850	Gasket kit	1	Only gaskets	●	●				
45	198.851	CEI 198851	Oil Seals Kit	1	Only oil seals	●	●				
46	198.846	550577	Oil Seal and Gasket Kit	1	Complete	●	●				
47	198.957	CEI 198957	Cylinder O-Ring Kit	1	For one cyl.	●	●				
48	198.916	CEI 198916	Engaging Ring Kit	1	Assy	●	●				
49	298.033	CEI 298033	Repair Kit	1		●	●				
50	298.188	CEI 298188	Synchro Rebuilt Kit	1	@	●	●				

Notes

(*) Old and New Generation. Can be replaced by Synchro rebuilt kit **298.188** (Fig. 50)
 (@) LATEST GENERATION. To be coupled together.

Date

05 / 2010

Table

0175

