



Roadranger®

More time on the road®

Illustrated Parts List

FO-8406A-ASX
July 2011

Contents

How To Use The Illustrated Parts List	3
CASE.....	4
CONTROLLER ECU & HARNESS.....	6
COUNTERSHAFT ASSY	8
GEAR DISPLAY MODULE.....	9
INERTIA BRAKE ASSEMBLY	10
INPUT SHAFT.....	11
KITS & ASSEMBLIES	12
MAINSHAFT ASSY.....	13
MISCELLANEOUS	15
REVERSE IDLER GEAR ASSY	16
SHIFT BAR HOUSING	17
SHIFT CONTROL	19
X-Y SHIFTER MODULE.....	20

How To Use The Illustrated Parts List

The information contained in this document is subject to frequent updates. Therefore, for the latest information available, please visit the interactive Electronic Parts Catalog at www.roadranger.com/epc.

Model Designation or Nomenclature

- For information regarding Model Designation and Nomenclature, visit www.roadranger.com.

Kits and Assemblies (K/A's)

- Kits and Assemblies contain groups of individual or assembled parts developed for optimal replacement or repair of a service problem.
- Kits and Assemblies are shown with applicable parts groupings in the parts listings.

Identifying Kits and Assemblies

A- Part numbers beginning with the letter 'A' are pre-assembled Production Assemblies

K- Part numbers beginning with the letter 'K' are kits that are not assembled

S- Part numbers beginning with the letter 'S' are pre-assembled Service Assemblies

- Note: Some Production Assemblies do not begin with a letter prefix (Midrange only).

Illustrations

- Illustrations show parts in assembly groups.
- Item numbers on illustrations correspond with parts listings on pages adjacent to the illustration.
- Notes are included on illustrations where additional information is needed.

Parts Listing

Parts listings are defined by parts groupings and are broken down by service assemblies. Parts listings identify a part for servicing with the following categories

- **Item Number** - corresponding with numbers on illustrations for part identification.
- **Current Part** - identifies part as it is available for service.
- **Description** - specifies part name or description.
- **Replaced Part** - quantity quantity required for assembly.
- **Quantity** - defines unique characteristics or requirements.
- **Notes** - indicates Kits or Assemblies that contain a particular part.
- **Kits/Assy's Where Used**

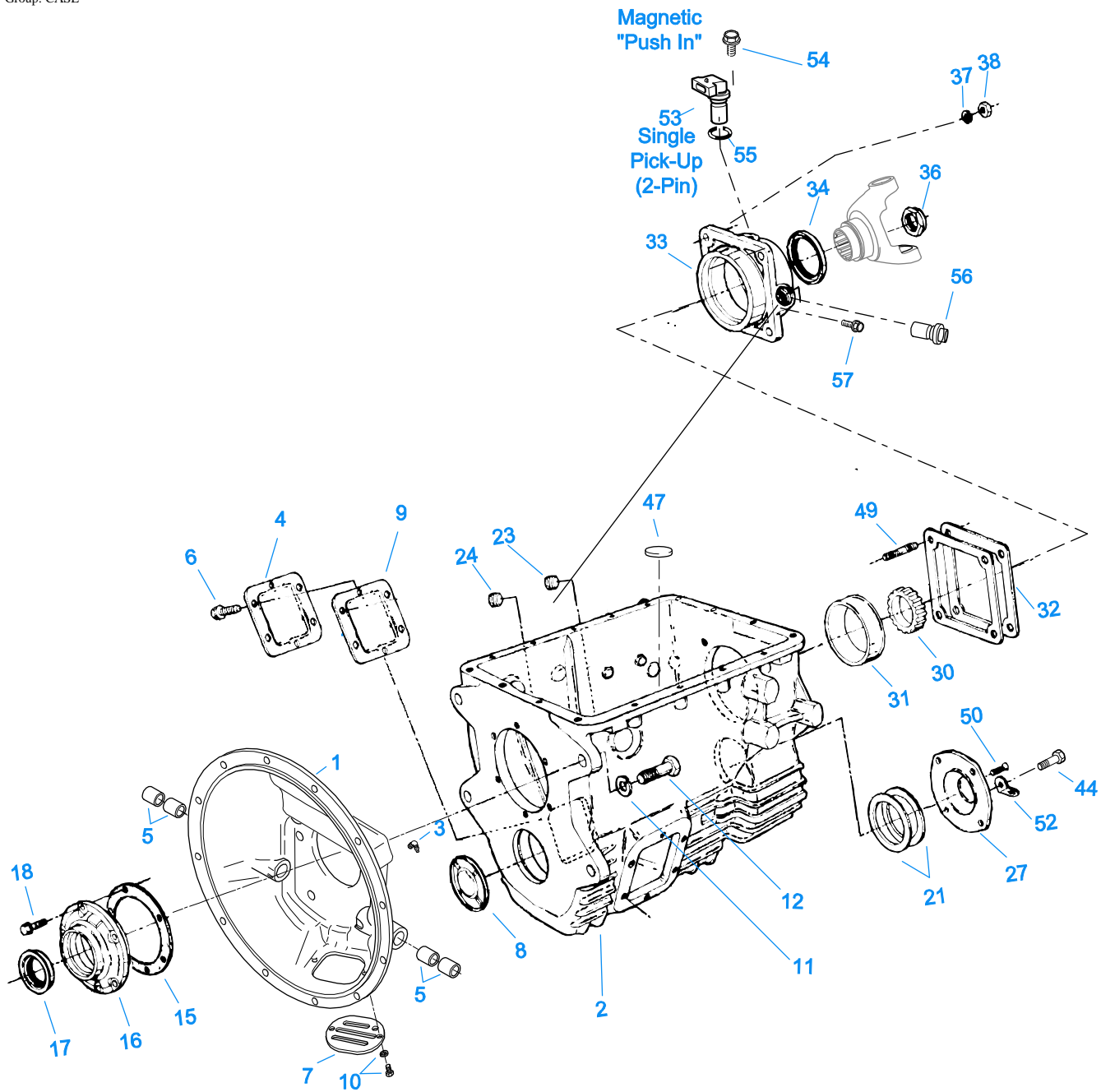

00185-09-01

CASE

Item	Current Part	Description	Replaced Part	Qty.	Notes	Kits/Assys Where Needed
1	A-5634	CLUTCH HSG ASSY	23726 ,3316236 ,3316237 ,A - 5632 ,A - 5771	1	#2 ALUMINUM, ABOVE CENTER LINE PULL TYPE	
2	A-7037	CASE ASSY	691411	1		
3	4300301	FITTING-45 DEGREE	11H15	2		
4	201398	PTO COVER		1		
5	12815	BUSHING		4		A-5634
6	239613	CAPSCREW		6	3/8"-16X5/8"	
7	23380	COVER	206466	1		A-5634

Item	Current Part	Description	Replaced Part	Qty.	Notes	Kits/Assys Where Needed
8	3315679	PLUG		1		K-3440
9	4305309	GASKET	1684	1		K-3648,K-7028
10	X-8L-408	SCREW & WASHER ASSY		2		
11	X-3-1000	LOCKWASHER		4	5/8"	
12	X-8-1011	CAPSCREW	1C1036	4	5/8"-11X2-1/4"	
15	3315659	GASKET		1		K-7028
16	4300888	FRONT BRG COVER-PULL		1		
16	4302356	FRONT BRG COVER-PULL		1		
17	4300121	OIL SEAL	3315623	1	SHAFT 1.873, WIDTH .375, OD 2.68	K-3440
18	239614	SCREW		6	5/16-18X.81	
21	3315681	SHIM .004		1		K-2183
21	3315682	SHIM .007		1		K-2183
21	3315683	SHIM .010		1		K-2183
21	3315684	SHIM .020		1		K-2183
21	4300977	SHIM .040		1		
23	X-12-1209	PIPE PLUG		1		
24	X-12-1207	PIPE PLUG	X12 1202 ,X12 1206	1	3/4" MAGNETIC	
27	4301607	C/S REAR BRG COVER		1		
30	3316160	SPEEDO ROTOR		1	16 TEETH	
31	711123	BEARING CUP		1		K-3440
32	3315662	SHIM .004		1		K-2183
32	3315663	SHIM .007		1		K-2183
32	3315664	SHIM .010		1		K-2183
32	3315665	SHIM .020		1		K-2183
32	4300978	SHIM .040		1		
33	S-2864	REAR BRG COVER ASSY	691423 ,691666	1		
34	4300119	OIL SEAL		1	SHAFT 2.753, WIDTH .5	K-3440,S-2864
36	K-3411	NUT KIT	21937 ,4301920 ,4304690	1		
37	239436	WASHER		4	1/2"	
38	86D8	NUT	86D08	4	1/2"-20	
44	X-8C-604	CAPSCREW		4	3/8"-16X1-1/4"	
47	14373	MAGNET		2		A-7037
49	239433	STUD		4	1/2"-20X2-5/16"	
50	X-12-405	PIPE PLUG		1		
52	238370	LIFTING EYE		1		
53	K-3231	SPEED SENSOR KIT	A - 6398 ,A - 6724	1	SINGLE PICK-UP (2 PIN)	
54	X-8C-409	CAPSCREW		1	1/4"-20X5/8"	
55	14142	-O- RING		1		K-3125,K-3638,S-2864
56	K-3125	SPEEDO PLUG KIT	4302707	2		
57	X-8C-409	CAPSCREW		2	1/4"-20X5/8"	

Group: CONTROLLER ECU & HARNESS

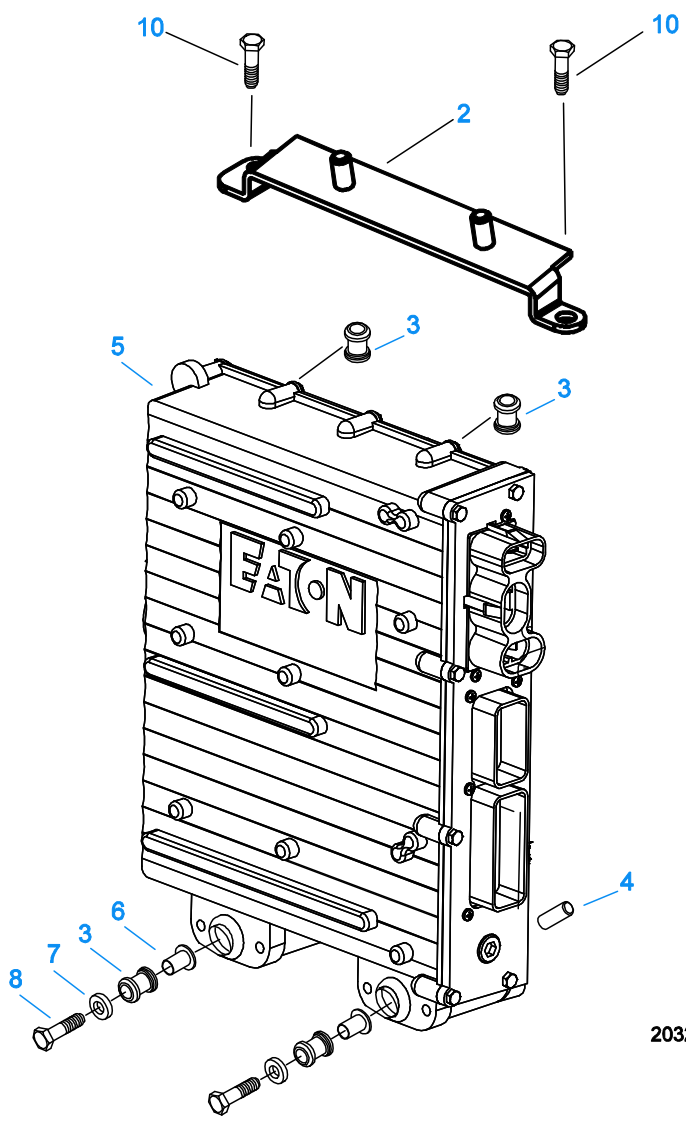
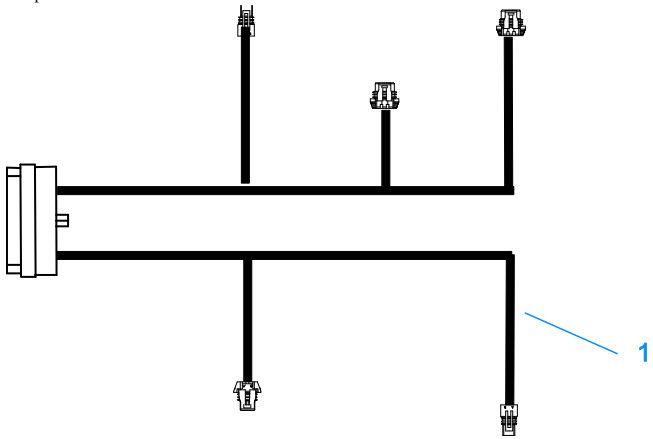

20320-09-01

CONTROLLER ECU & HARNESS

Item	Current Part	Description	Replaced Part	Qty.	Notes	Kits/Assys Where Needed
1	K-3525	TRANSMISSION	691667	1		

Item	Current Part	Description	Replaced Part	Qty.	Notes	Kits/Assys Where Needed
2	A-7023	HARNESS KIT ECU MTG BRACKET ASSY	691428 ,691527	1		
3	4301367	MOUNTING PAD		4		
4	691528	ECU MOUNTING SPACER		2		
5	K-3435RX	REMAN EXCHANGE TRANSMISSION CONTROLLER KIT	A - 6991, K-3435, K-3435R	1		
6	4301369	SLEEVE		2		
7	4302114	WASHER		2		
8	X-8-558	CAPSCREW		2		
10	X-8-688	CAPSCREW		2	3/8"-16X1"	

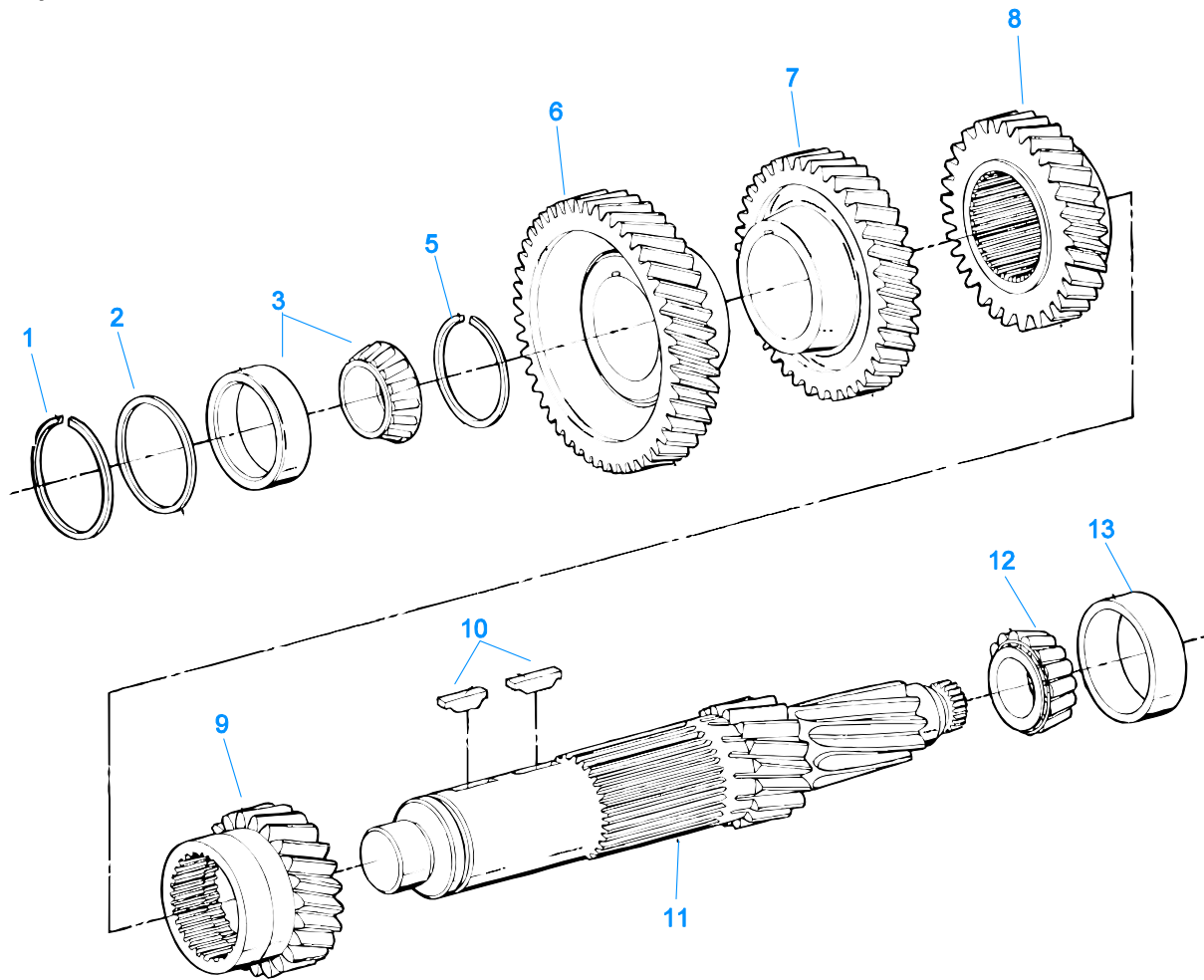

00303-8/93 CS 53

COUNTERSHAFT ASSY

Item	Current Part	Description	Replaced Part	Qty.	Notes	Kits/Assys Where Needed
1	3315686	SNAP RING		1		
2	3315687	WASHER		1		K-3422,K-3440
3	K-3795	COUNTERSHAFT BRG KIT	1313645, 791943	1		K-3422
5	3315752	SNAP RING	3315751	1		
6	4304541	DRIVE GEAR-CNTRSHFT		1		
7	4304542	5TH GEAR-CNTRSHFT		1		
8	4304097	4TH GEAR-CNTRSHFT	4304099	1		
9	4304056	3RD GEAR-CNTRSHFT	4304062	1		
10	230292	KEY		2		K-3422
11	4303238	COUNTERSHAFT	3315740	1		
12	658981	BEARING CONE		1		K-3440
13	660181	BEARING CUP		1		K-3440

Group: GEAR DISPLAY MODULE

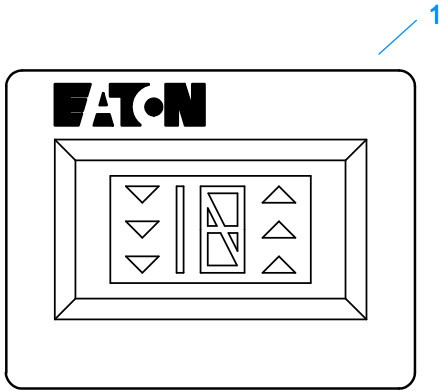

30317-03-01

GEAR DISPLAY MODULE

Item	Current Part	Description	Replaced Part	Qty.	Notes	Kits/Assys Where Needed
1	K-3199	GEAR DISPLAY KIT	4301944 ,A - 6416	1		

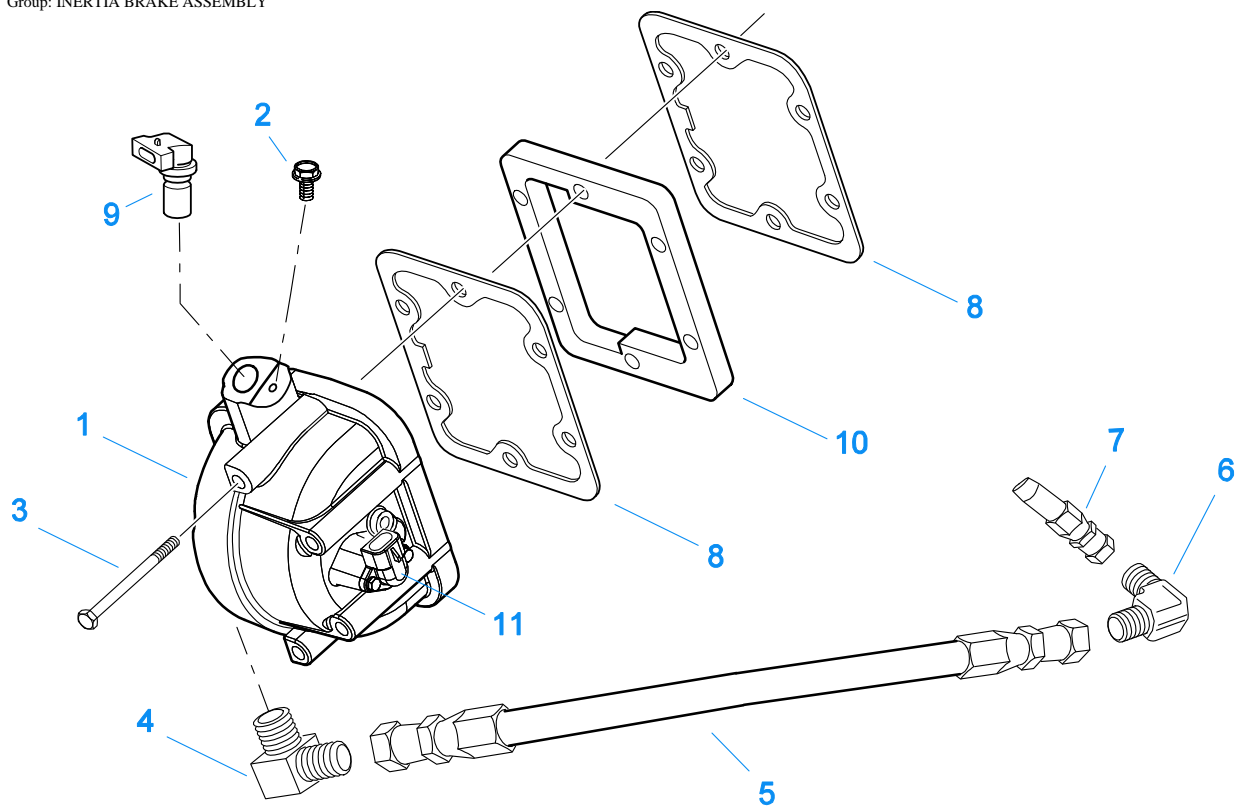

20426-10-01

INERTIA BRAKE ASSEMBLY

Item	Current Part	Description	Replaced Part	Qty.	Notes	Kits/Assys Where Needed
1	K-3648	INERTIA BRAKE KIT	A - 7434 ,K - 3508, A-7828	1		
2	X-8C-409	CAPSCREW		1	1/4"-20X5/8"	
3	X-8C-690	CAPSCREW		6		
4	4303677	ELBOW		1		
5	5588205	OIL HOSE ASSY (13.5")	5586911 ,5586922	1	13.5"	
6	691651	ELBOW, 90 DEG MALE		1		
7	691517	FILTER FITTING		1		
8	4305309	GASKET	1684	2		K-3648,K-7028
9	K-3231	SPEED SENSOR KIT	A - 6398 ,A - 6724	1	SINGLE PICK-UP (2 PIN)	
10	691519	PLATE-ADAPTER 6 BOLT PTO		1		
11	K-3638	I-BRAKE CONNECTOR KIT	691499	1		

Group: INPUT SHAFT

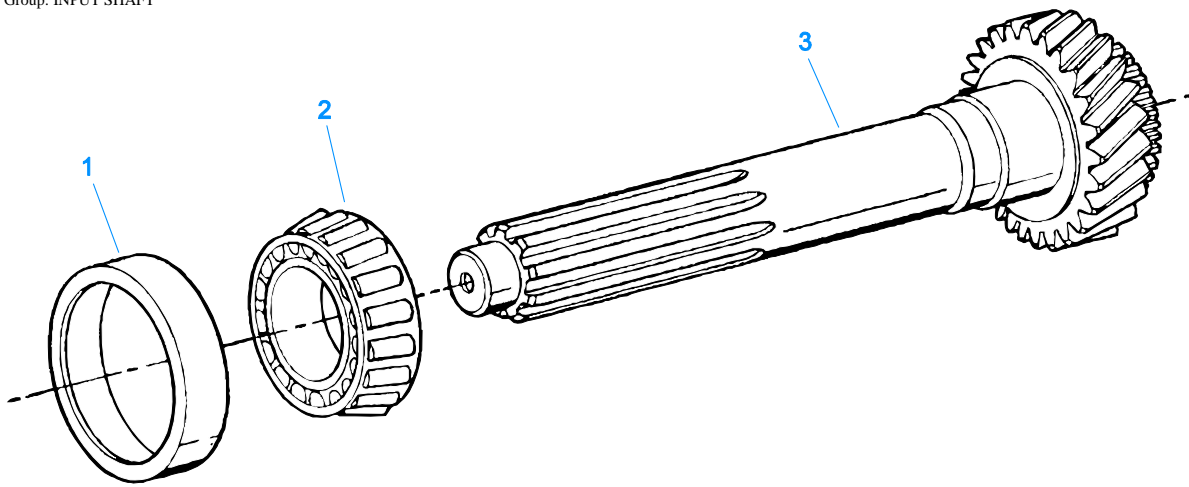

00401-8/93 IS 62

INPUT SHAFT

Item	Current Part	Description	Replaced Part	Qty.	Notes	Kits/Assys Where Needed
1	675250	BEARING CUP		1	1.75" INPUT	K-3440
2	742259	BEARING CONE		1	1.75" INPUT	K-3440
3	4304540	INPUT SHAFT-1.75" PULL		1	PILOT 25MM - USE 4300888 OR 4302356 FRONT BEARING COVER	

KITS & ASSEMBLIES

Item	Current Part	Description	Replaced Part	Qty.	Notes	Kits/Assys Where Needed
K-2183		SHIM KIT		1		K-3440
K-3125		SPEEDO PLUG KIT	4302707	1		
K-3199		GEAR DISPLAY KIT	4301944 ,A - 6416	1		
K-3231		SPEED SENSOR KIT	A - 6398 ,A - 6724	1	SINGLE PICK-UP (2 PIN)	
K-3411		NUT KIT	21937 ,4301920 ,4304690	1		
K-3422		SMALL PARTS KIT		1		
K-3435RX		REMAN EXCHANGE TRANSMISSION CONTROLLER KIT	A - 6991, K-3435, K- 3435R	1		
K-3436		XY SHIFTER KIT	691381 ,A - 7034	1		
K-3438		POSITION SENSOR KIT	691551 ,691926	1		
K-3440		BASIC REBUILD KIT		1		
K-3525		TRANSMISSION HARNES KIT	691667	1		
K-3528		REVERSE IDLER GEAR KIT	4301491	1		
K-3638		I-BRAKE CONNECTOR KIT	691499	1		
K-3648		INERTIA BRAKE KIT	A - 7434 ,K - 3508	1		
K-3795		COUNTERSHAFT BRG KIT	1313645, 791943	1		
K-7028		GASKET KIT		1		
S-2864		REAR BRG COVER ASSY	691423 ,691666	1		
S-2865		SHIFT BAR HOUSING ASSY	691655 ,A - 7053	1		
S-2989		PUSHBUTTON ASSEMBLY	S - 2985	1		

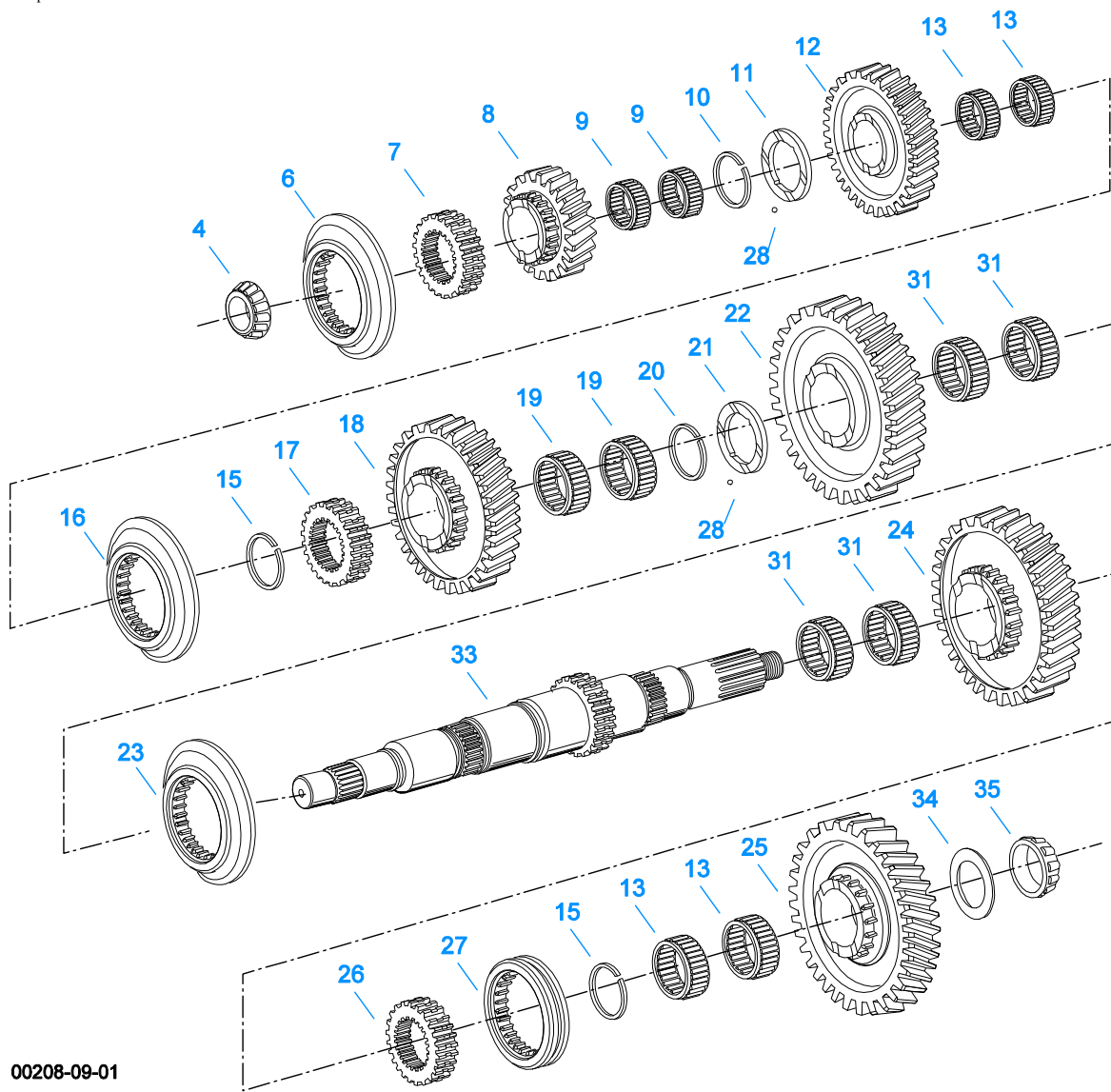

00208-09-01

MAINSHAFT ASSY

Item	Current Part	Description	Replaced Part	Qty.	Notes	Kits/Assys Where Needed
4	710787	BEARING CONE		1		K-3440
6	691415	SLIDING CLUTCH (5TH/6TH)		1		
7	4301476	CLUTCH HUB 5/6		1		
8	4304543	5TH GEAR-MAINSHAFT		1		
9	3315737	BEARING		2		K-3440
10	3315728	SNAP RING	3315729	1		K-3422
11	3315727	WASHER		1		K-3422
12	4304098	4TH GEAR-MAINSHAFT	4304401	1		
13	4124075	BEARING		4		K-3440
15	3315725	SNAP RING		2		K-3422,K-3440
16	691414	SLIDING CLUTCH (3RD/4TH)		1		
17	4301475	CLUTCH HUB 3/4		1		
18	4304057	3RD GEAR-MAINSHAFT	4304063	1		
19	3315722	BEARING		2		K-3440
20	3315717	SNAP RING	3315718	1		K-3422
21	3315719	WASHER		1		K-3422
22	4303231	2ND GEAR-MAINSHAFT	4301482	1		
23	4301852	SLIDING CLUTCH 1ST/REV		1		

Item	Current Part	Description	Replaced Part	Qty.	Notes	Kits/Assys Where Needed
24	4303230	1ST GEAR-MAINSHAFT	4301483	1		
25	4301484	REVERSE GEAR- MAINSHAFT		1		
26	4301474	CLUTCH HUB-REV		1		
27	4301473	SLIDING CLUTCH-REV		1		
28	10J06	STEEL BALL		2	3/16"	K-3422
31	3315703	BEARING		4		K-3440
33	4301468	MAINSHAFT		1		
34	4301492	WASHER		1		K-3422
35	5557003	BEARING CONE		1		K-3440

MISCELLANEOUS

Item	Current Part	Description	Replaced Part	Qty.	Notes	Kits/Assys Where Needed
71203		SILICONE LUBE		1	8 OZ (236.59 CC)-FLEET SIZE	
71204		ADHESIVE SEALANT		1	0.5 CC (SINGLE APPLICATION SIZE)	
71205		SEALANT		1	2 CC (SINGLE APPLICATION SIZE)	K-3648
71206		SILICONE LUBE		1	4 CC (SINGLE APPLICATION SIZE)	
71231		GASKET SEALANT		1	8 MILLILITER SIZE	K-2183
71232		THREAD ADHESIVE		1	10 MILLILITER SIZE	K-3648

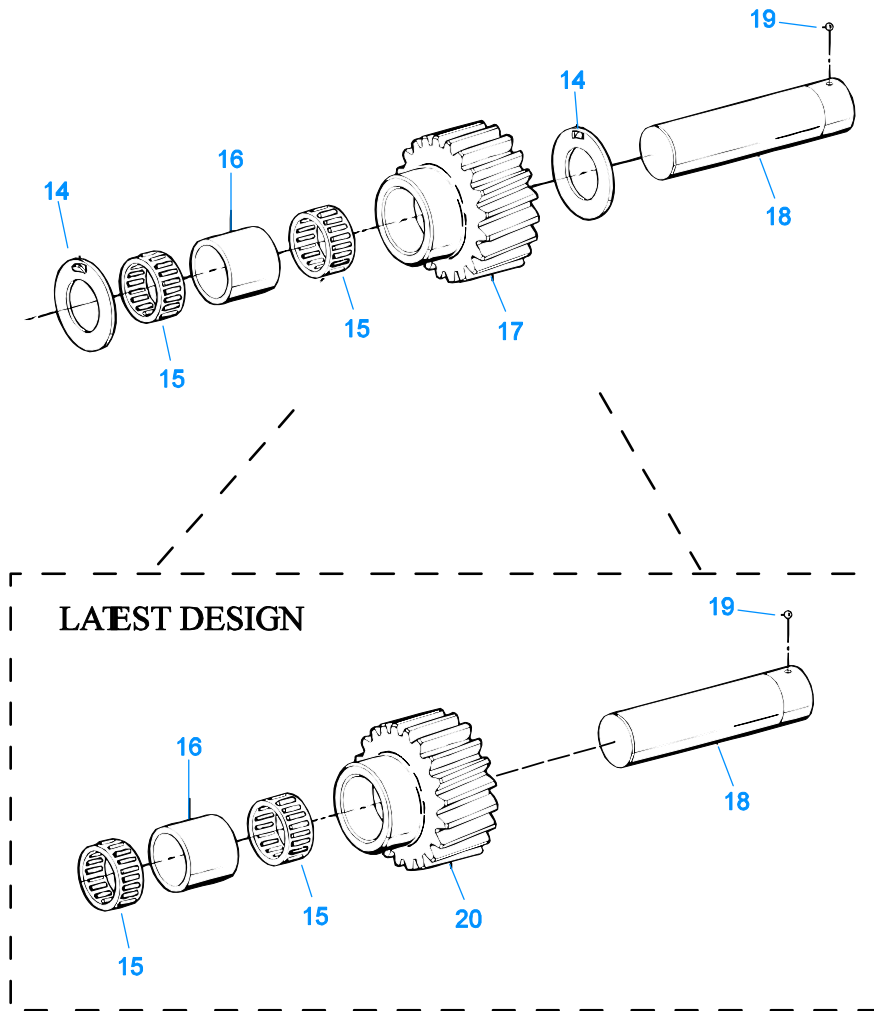

00453-8-93

REVERSE IDLER GEAR ASSY

Item	Current Part	Description	Replaced Part	Qty.	Notes	Kits/Assys Where Needed
14	3315673	WASHER		2		K-3422
15	3315674	BEARING		2		K-3440
16	3315676	SPACER		1		
17	K-3528	REVERSE IDLER GEAR KIT	4301491	1		
18	3315672	REVERSE IDLER SHAFT		1		
19	10J06	STEEL BALL		1	3/16"	K-3422
20	4304318	REVERSE IDLER GEAR		1		K-3528

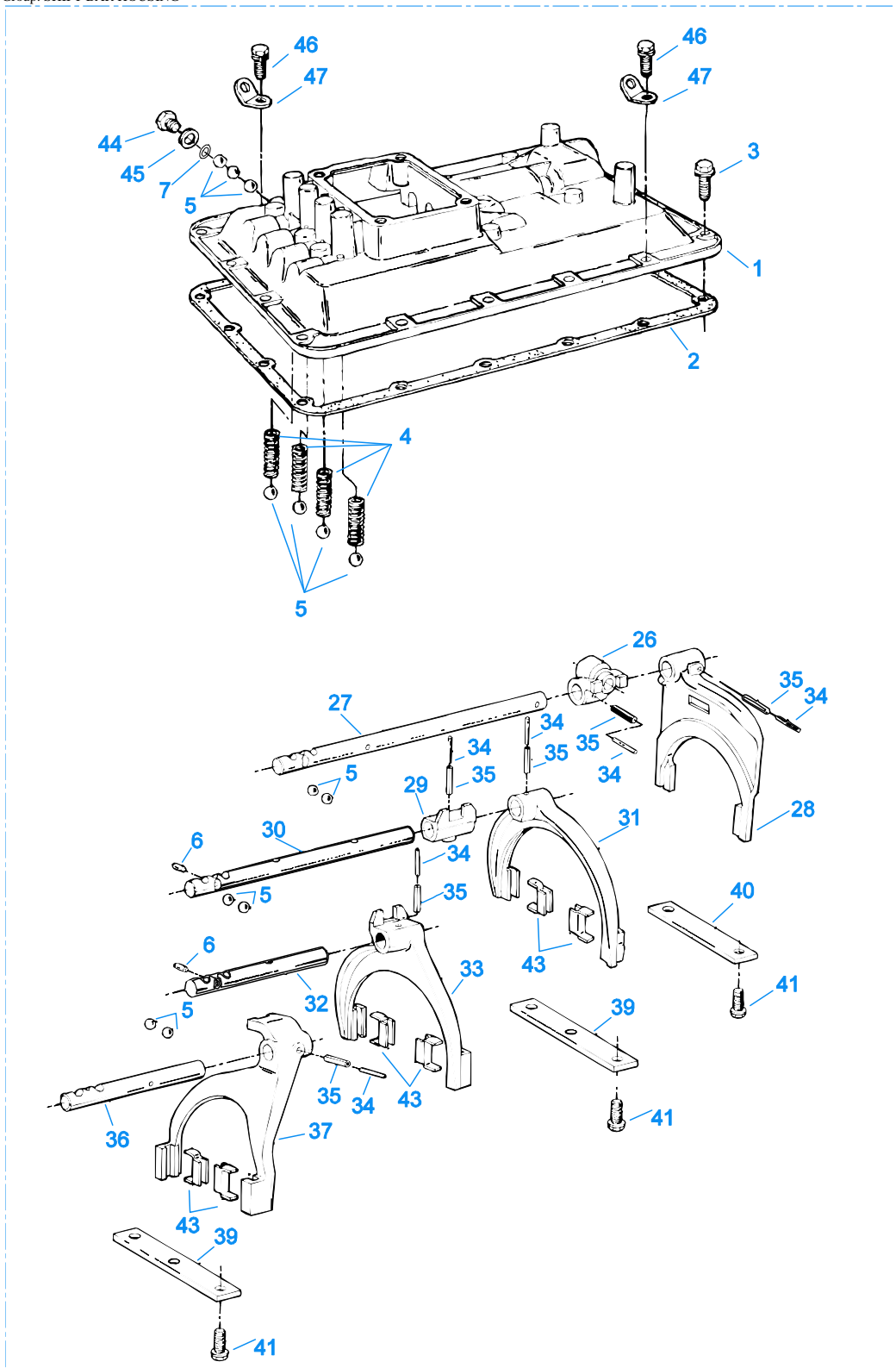

999

00105A-09-01

SHIFT BAR HOUSING

Item	Current Part	Description	Replaced Part	Qty.	Notes	Kits/Assys Where Needed
1	S-2865	SHIFT BAR HOUSING	691655 .A - 7053	1		

Item	Current Part	Description	Replaced Part	Qty.	Notes	Kits/Assys Where Needed
		ASSY				
2	4300854	GASKET	3315678	1		K-7028,S-2865
3	X-8C-600	CAPSCREW	239611	12	3/8"-16X1"	
4	691644	SPRING		4		K-3440
5	10J14	STEEL BALL		13	7/16"	K-3422
6	201044	PIN		2		
7	4301719	BALL RETAINER- REVERSE		1		
26	691526	SHIFT BLOCK - REVERSE		1		
27	691654	YOKE BAR - REVERSE	691422	1		
28	3315897	SHIFT YOKE ASSY		1		
29	691522	SHIFT BLOCK (1ST/2ND)		1		
30	691419	YOKE BAR (1ST/2ND)		1		
31	3315772	SHIFT YOKE ASSY	3315770	1		
32	691420	YOKE BAR (3RD/4TH)		1		
33	A-7038	YOKE ASSY (3RD/4TH)	691524	1		
34	1JM6028	PIN		6		
35	1JM3528	PIN		6		
36	691421	YOKE BAR (5TH/6TH)		1		
37	A-7039	YOKE ASSY (5TH/6TH)	691525	1		
39	4301279	SHIFT BAR RETAINER	3315756	2		
40	3315757	SHIFT BAR RETAINER		1		
41	233043	CAPSCREW		8	3/8"-16X1"	
43	227675	INSERT - YOKE PAD		6		A-7038,A-7039,K-3422
44	235052	CA PLUG		1	9/16 - 18	
44	4303656	PLUG	15917	1	9/16 - 18, THREADED	
45	15900	GASKET		1		K-7028,S-2865
46	X-8-688	CAPSCREW		3	3/8"-16X1"	
47	238370	LIFTING EYE		3		
999	S-2865	SHIFT BAR HOUSING ASSY	691655 ,A - 7053	1		

Group: SHIFT CONTROL

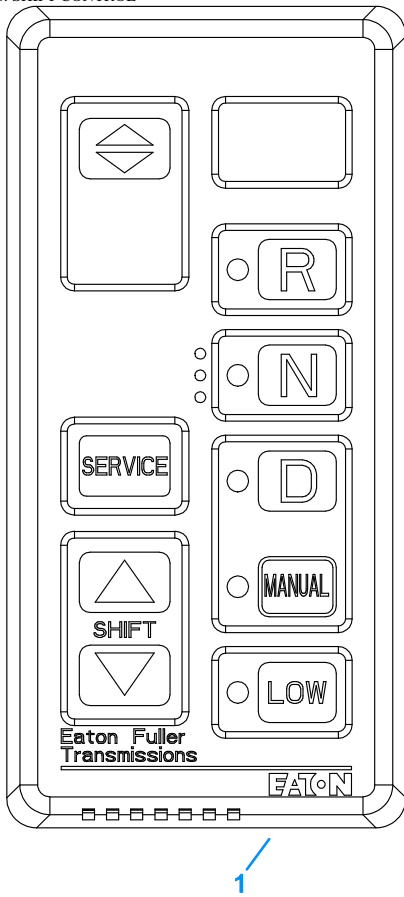

20327-07-07

SHIFT CONTROL

Item	Current Part	Description	Replaced Part	Qty.	Notes	Kits/Assys Where Needed
1	S-2989	PUSHBUTTON ASSEMBLY	S - 2985	1		

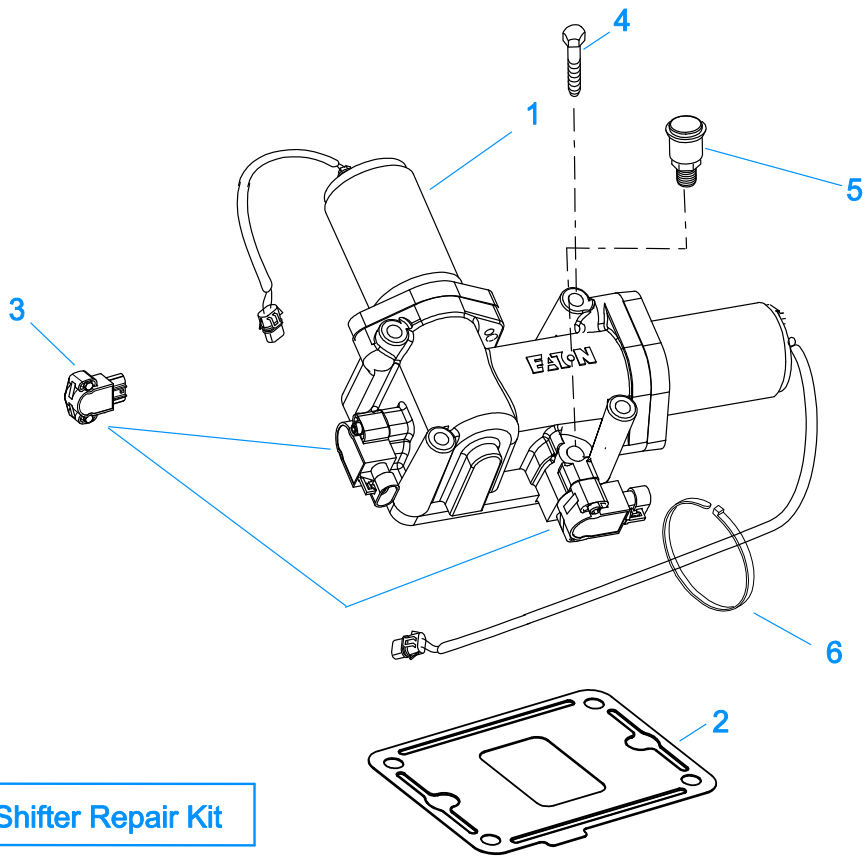

7 XY Shifter Repair Kit

20230-09-01

X-Y SHIFTER MODULE

Item	Current Part	Description	Replaced Part	Qty.	Notes	Kits/Assys Where Needed
1	K-3436	XY SHIFTER KIT	691381 ,A - 7034	1		
2	4305452	GASKET	4301958	1		K-3436,K-4009
3	K-3438	POSITION SENSOR KIT	691551 ,691926	2		
4	X-8C-615	CAPSCREW		4		
5	4304602	BREATHER	23605	1	1/4" NPT	
6	5559348	TY-RAP		5		K-3525
7	K-4009	XY SHIFTER REPAIR KIT		1		

